

# QP1 Series - Positive displacement pumps

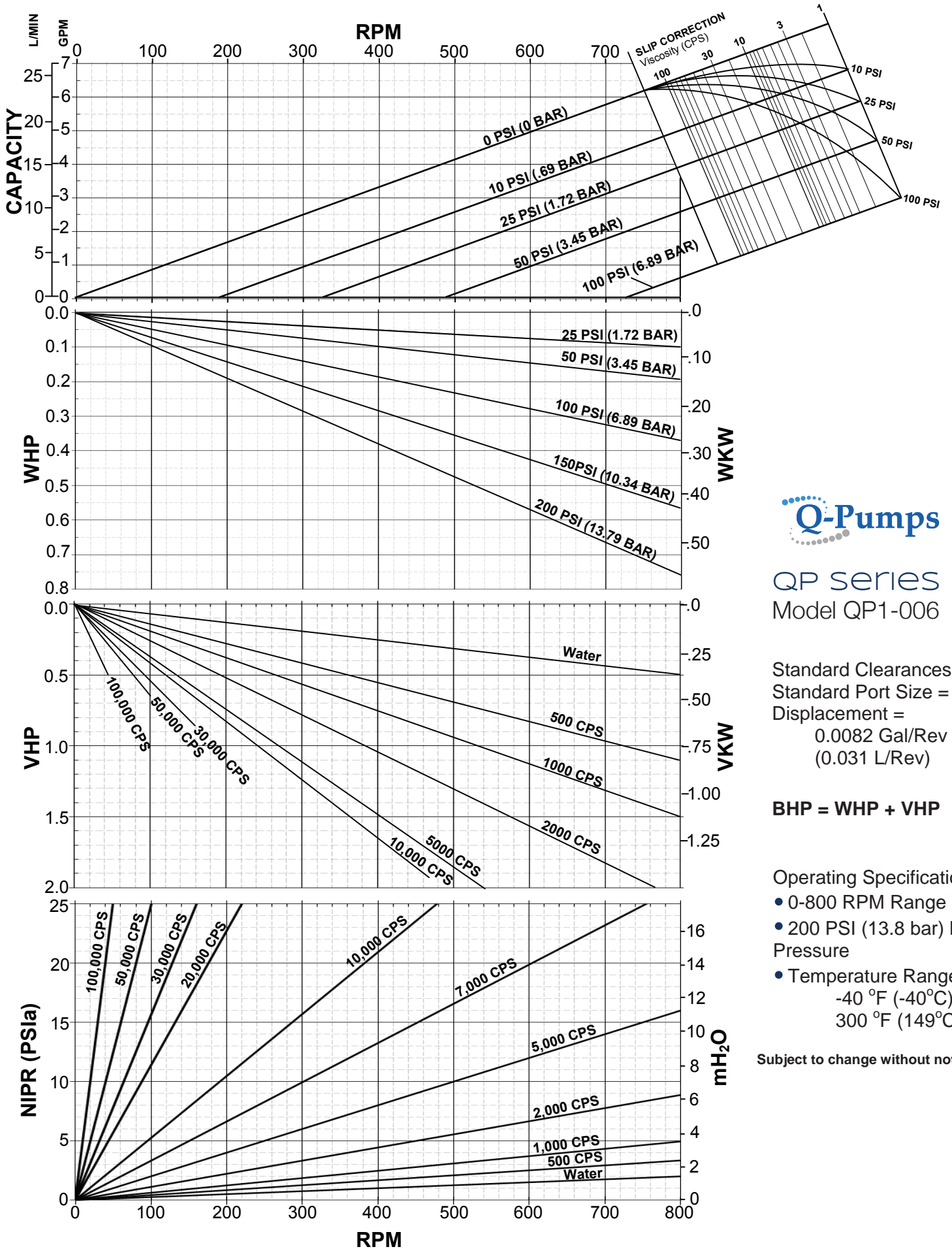

QP series  
Model QP1-006

Standard Clearances  
Standard Port Size = 1.0"  
Displacement =  
0.0082 Gal/Rev  
(0.031 L/Rev)

**BHP = WHP + VHP**

- Operating Specifications:
- 0-800 RPM Range
  - 200 PSI (13.8 bar) Max. Pressure
  - Temperature Range  
-40 °F (-40°C) to  
300 °F (149°C)

Subject to change without notice

# QP1 Series - Positive displacement pumps

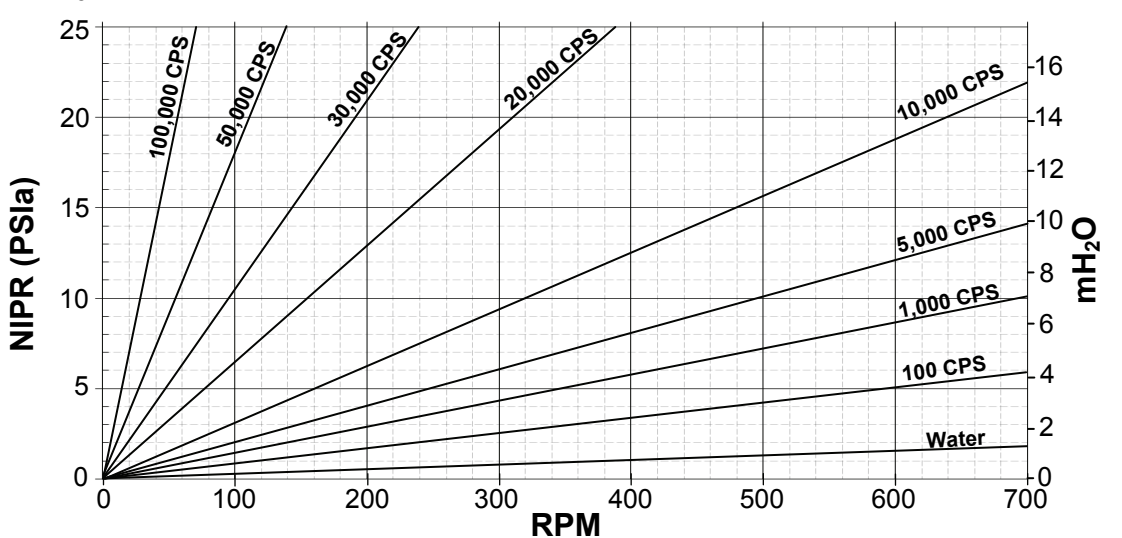
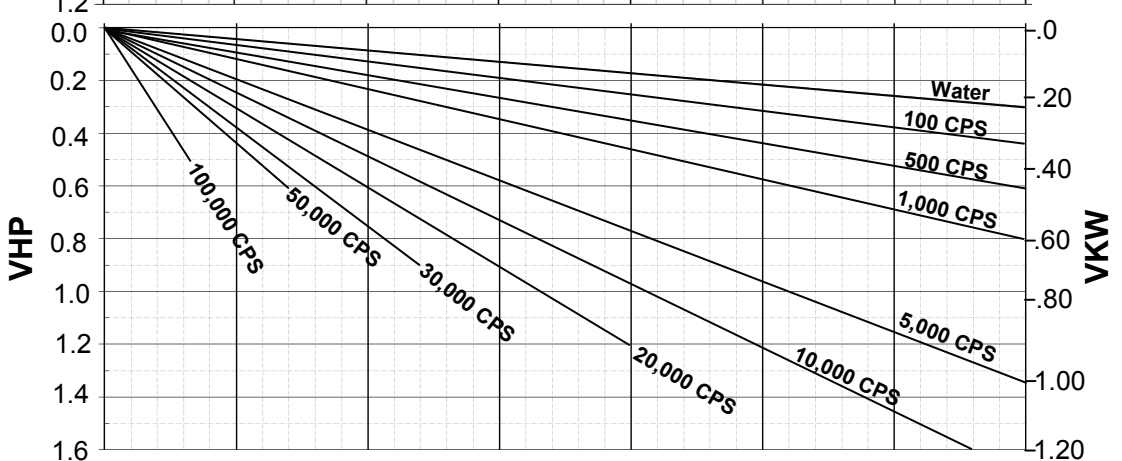
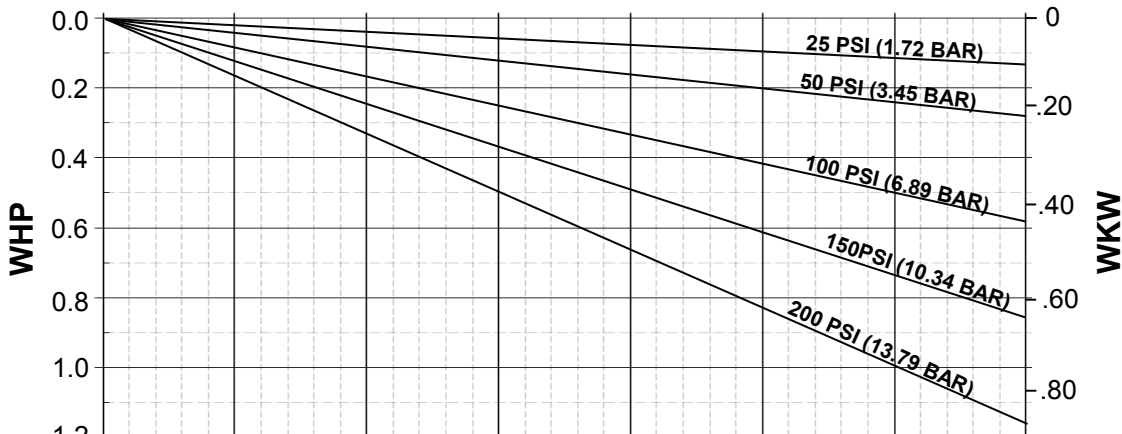
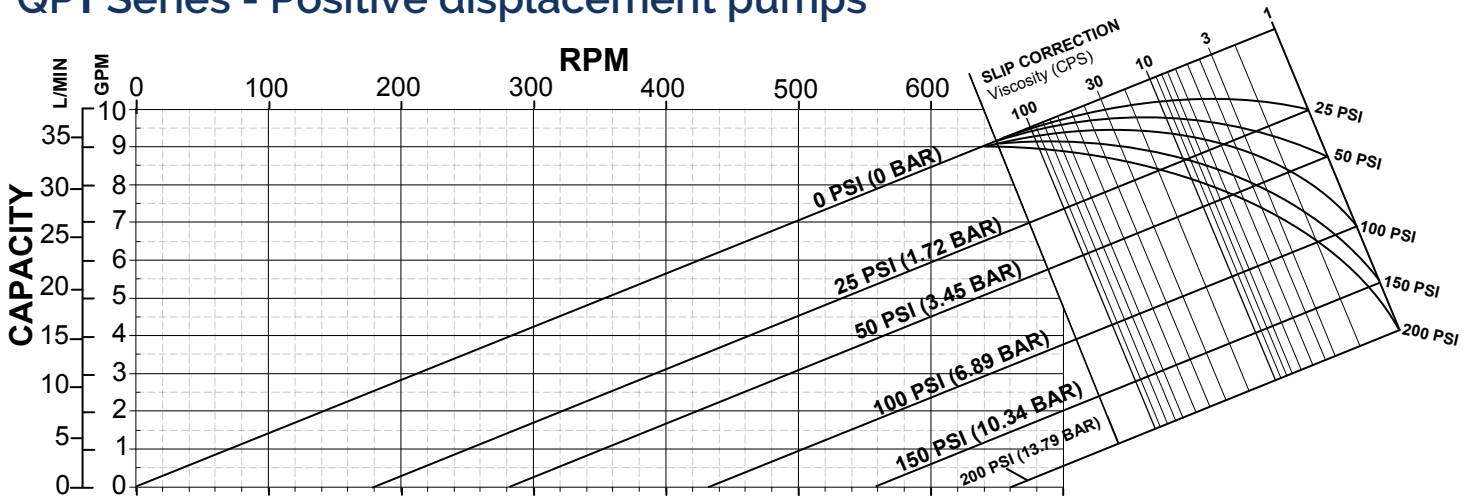

QP Series  
Model QP1-015

Standard Clearances  
Standard Port Size = 1.5"  
Displacement =  
0.014 Gal/Rev  
(0.054 L/Rev)

**BHP = WHP + VHP**

- Operating Specifications:
- 0-700 RPM Range
  - 200 PSI (13.8 bar) Max. Pressure
  - Temperature Range  
-40 °F (-40°C) to  
300 °F (149°C)

Subject to change without notice

# QP1 Series - Positive displacement pumps

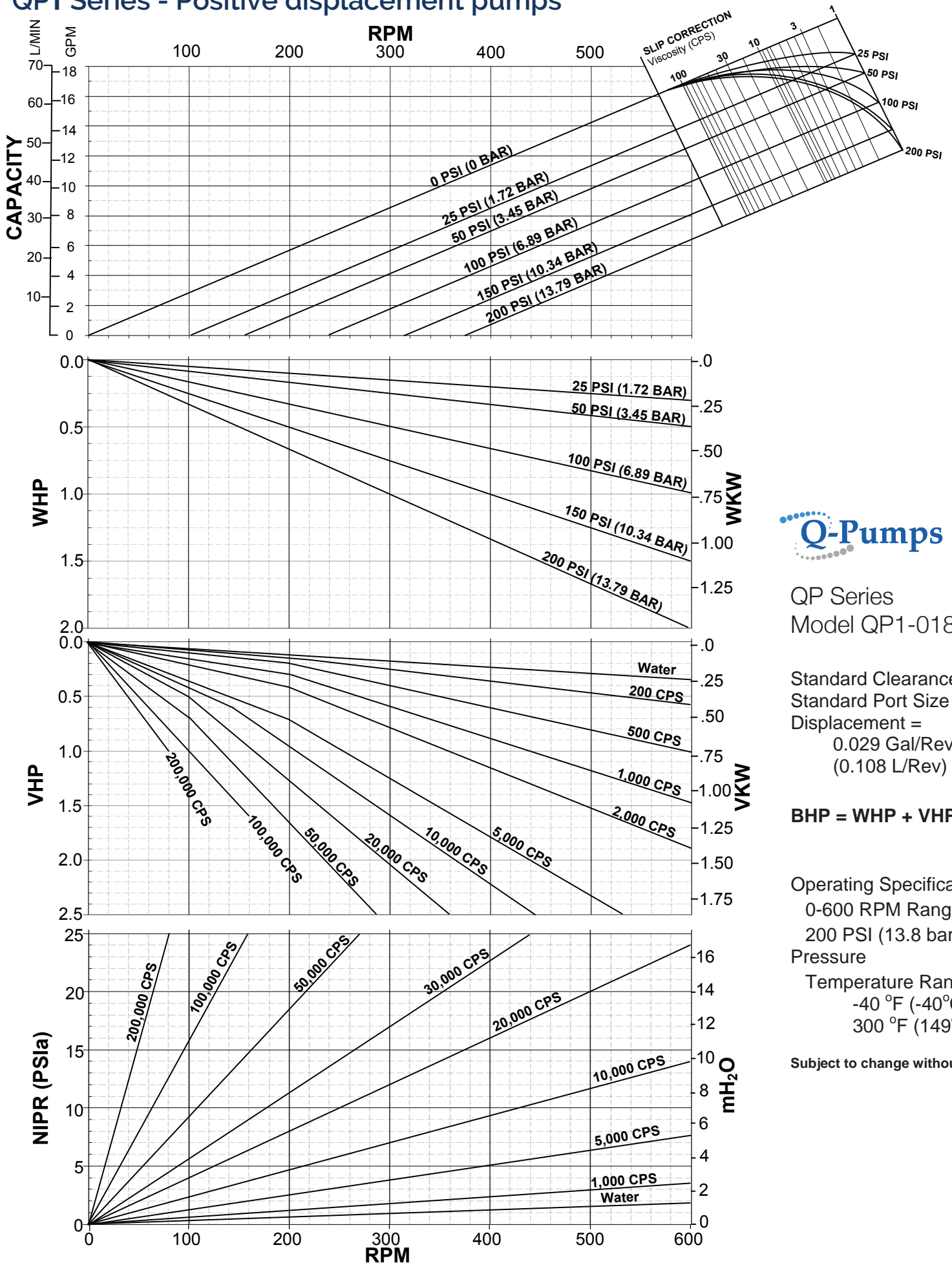

QP Series  
Model QP1-018

Standard Clearances  
Standard Port Size = 1.5"  
Displacement =  
0.029 Gal/Rev  
(0.108 L/Rev)

**BHP = WHP + VHP**

Operating Specifications:  
0-600 RPM Range  
200 PSI (13.8 bar) Max. Pressure  
Temperature Range  
-40 °F (-40°C) to  
300 °F (149°C)

Subject to change without notice

# QP1 Series - Positive displacement pumps

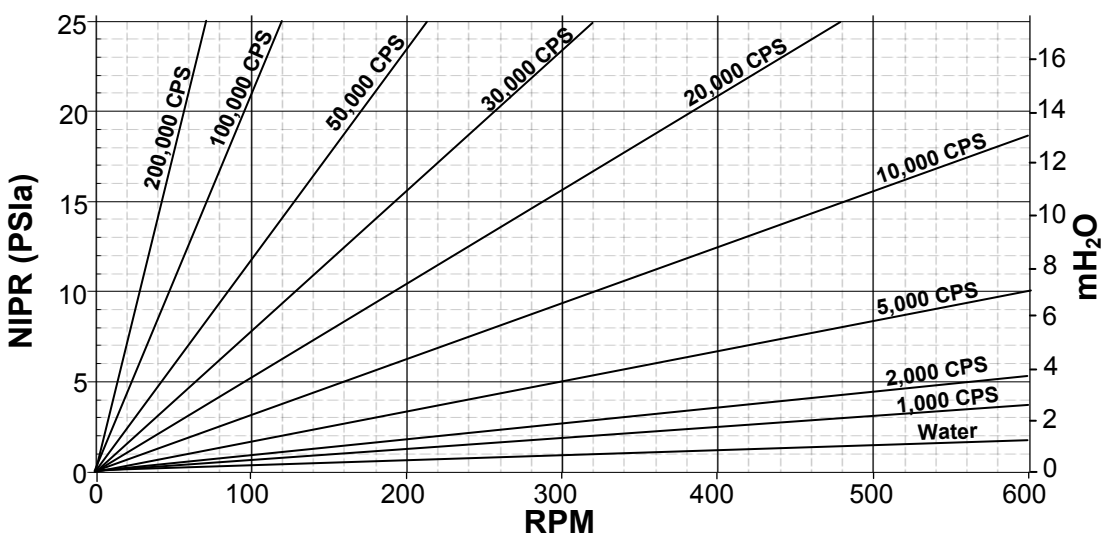
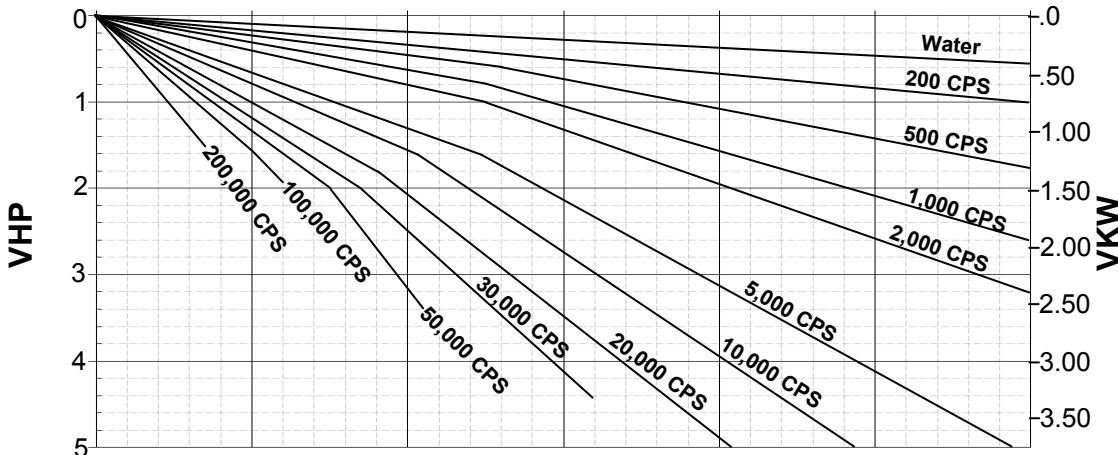
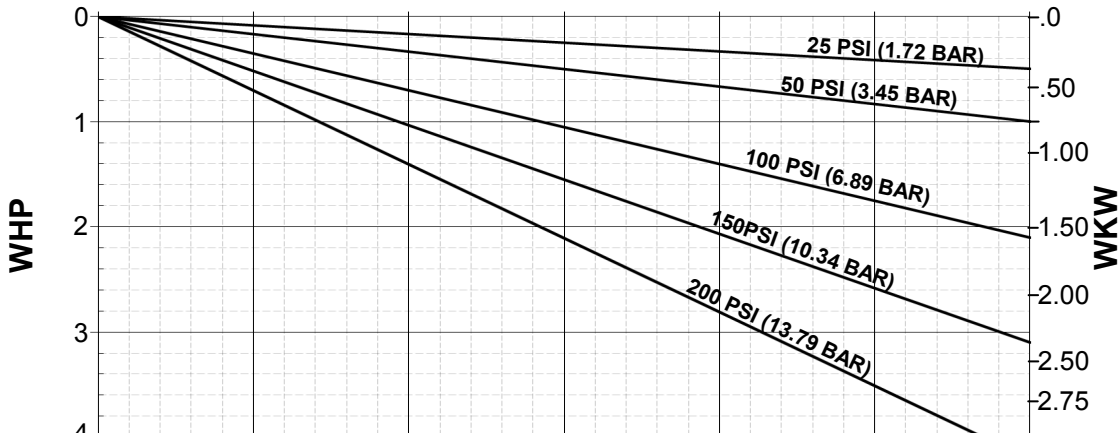
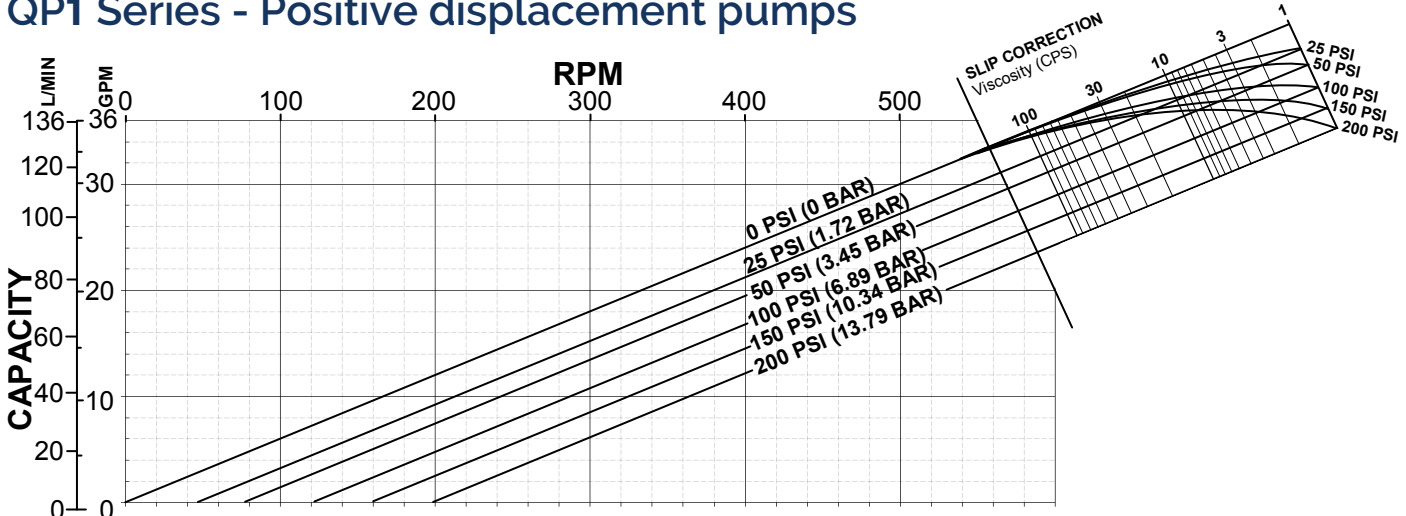

QP Series  
Model QP1-030

Standard Clearances  
Standard Port Size = 1.5"  
Displacement =  
0.060 Gal/Rev  
(0.227 L/Rev)

**BHP = WHP + VHP**

Operating Specifications:  
0-600 RPM Range  
200 PSI (13.8 bar) Max. Pressure  
Temperature Range  
-40 °F (-40°C) to  
300 °F (149°C)

Subject to change without notice

# QP1 Series - Positive displacement pumps

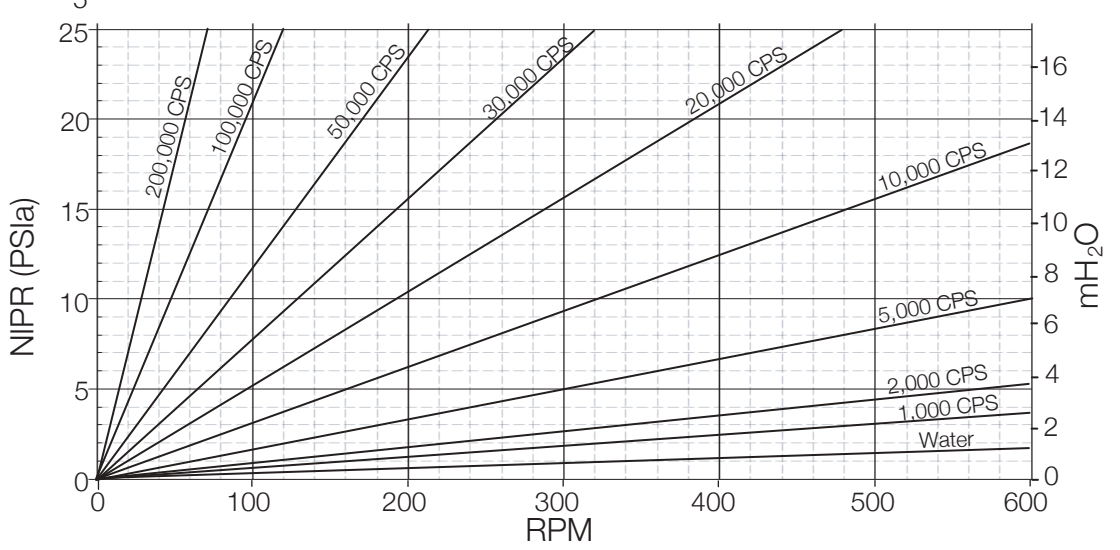
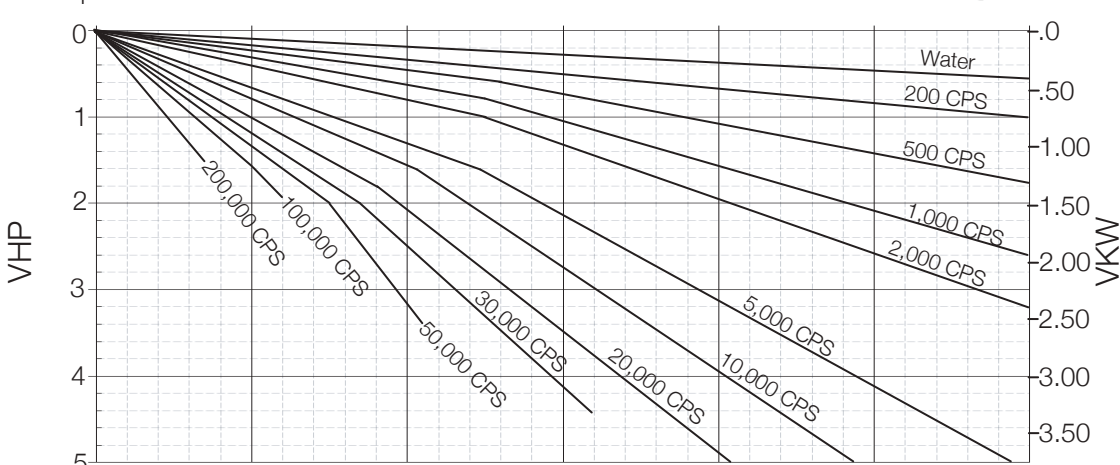
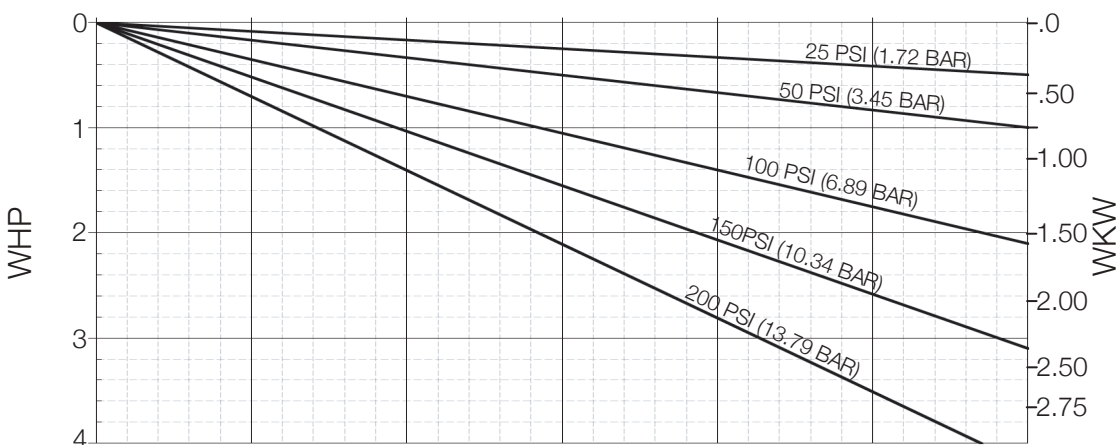
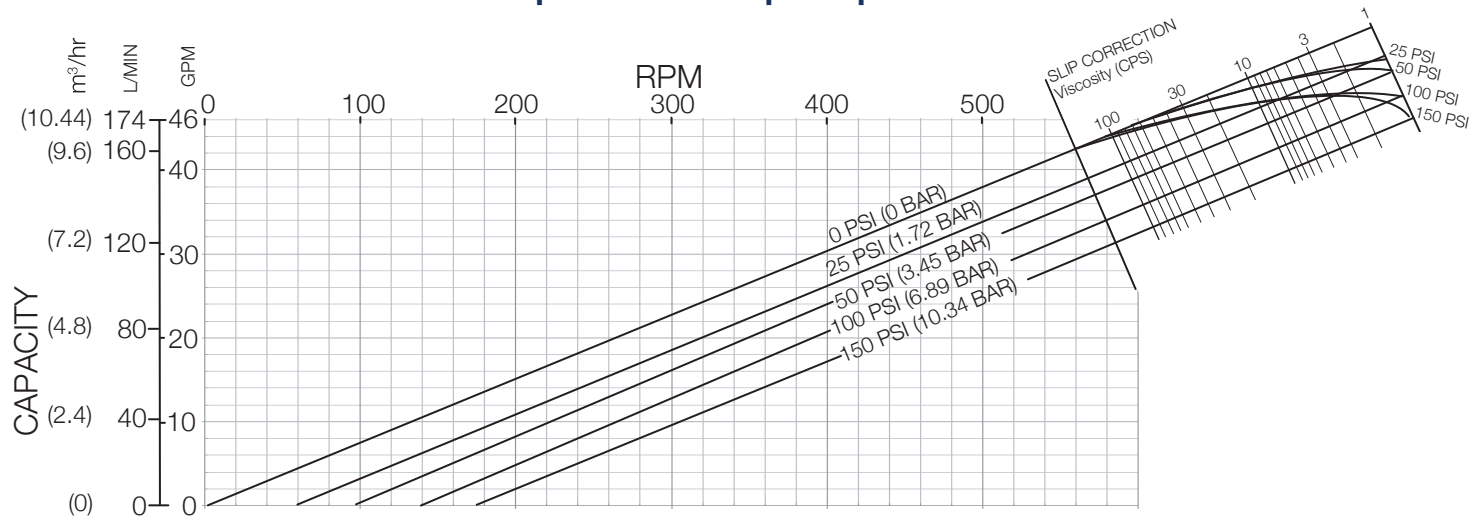

QP Series  
Model QP1-040

Standard Clearances  
Standard Port Size = 2.0"  
Displacement =  
0.076Gal/Rev  
(0.288 L/Rev)

**BHP = WHP + VHP**

- Operating Specifications:
- 0-600 RPM Range
  - 150 PSI (10.3 bar) Max. Pressure
  - Temperature Range -40 °F (-40°C) to 300 °F (149 °C)

Subject to change without notice

# QP1 Series - Positive displacement pumps

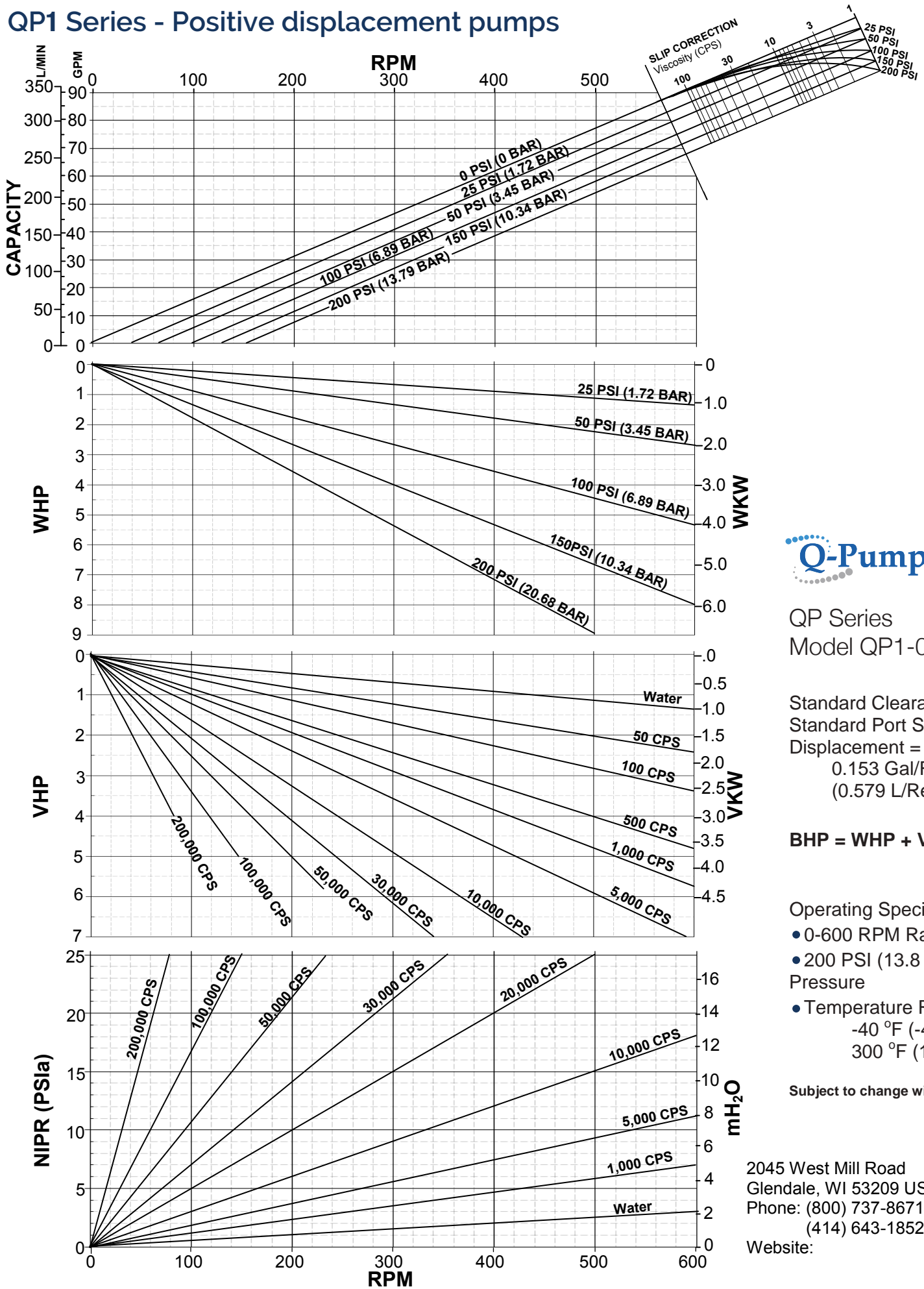

QP Series  
Model QP1-060

Standard Clearances  
Standard Port Size = 2.5"  
Displacement =  
0.153 Gal/Rev  
(0.579 L/Rev)

**BHP = WHP + VHP**

- Operating Specifications:
- 0-600 RPM Range
  - 200 PSI (13.8 bar) Max. Pressure
  - Temperature Range  
-40 °F (-40°C) to  
300 °F (149°C)

Subject to change without notice

2045 West Mill Road  
Glendale, WI 53209 USA  
Phone: (800) 737-8671  
(414) 643-1852  
Website:

# QP1 Series - Positive displacement pumps

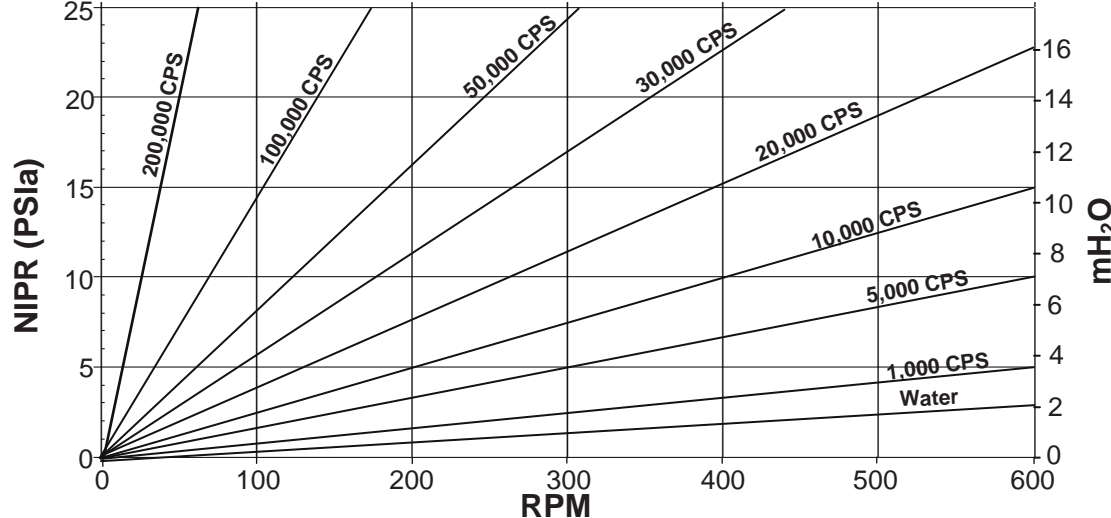
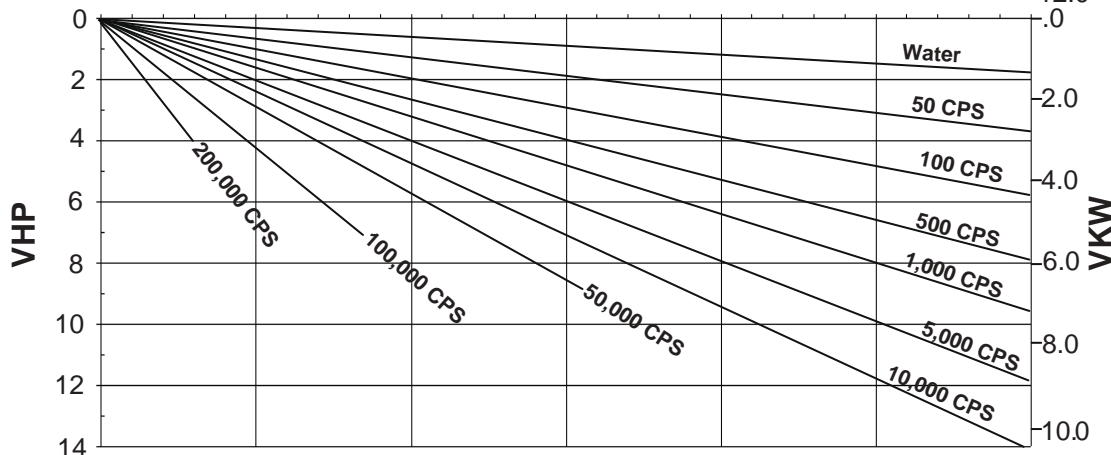
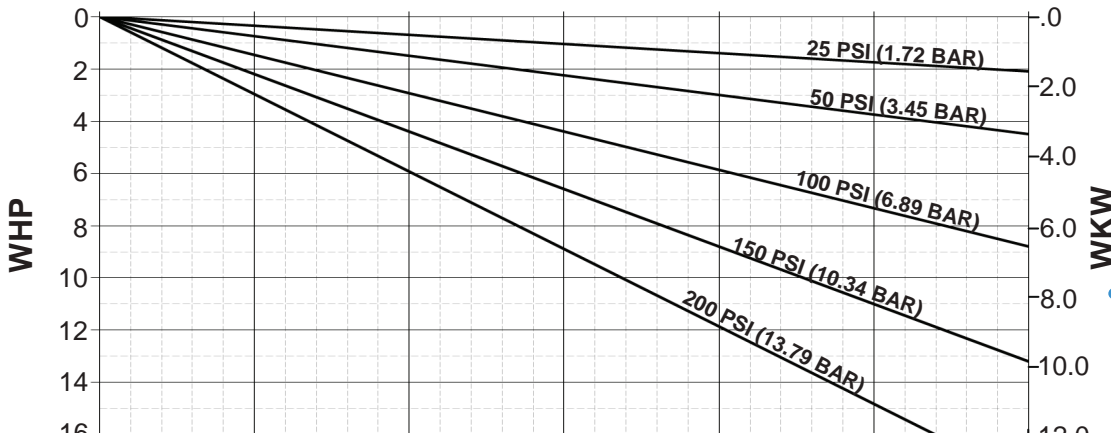
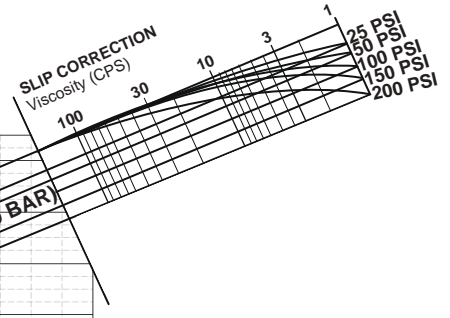
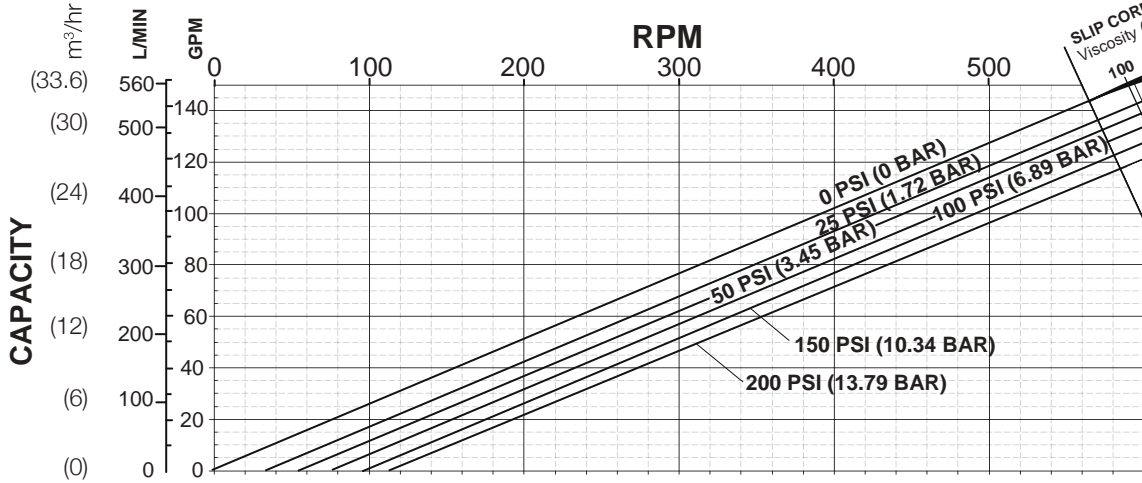

QP Series  
Model QP1-130

Standard Clearances  
Standard Port Size = 3.0"  
Displacement =  
0.254 Gal/Rev  
(0.961 L/Rev)

**BHP = WHP + VHP**

- Operating Specifications:
- 0-600 RPM Range
  - 200 PSI (13.8 bar) Max. Pressure
  - Temperature Range  
-40 °F (-40°C) to  
300 °F (149°C)

Subject to change without notice

# QP1 Series - Positive displacement pumps

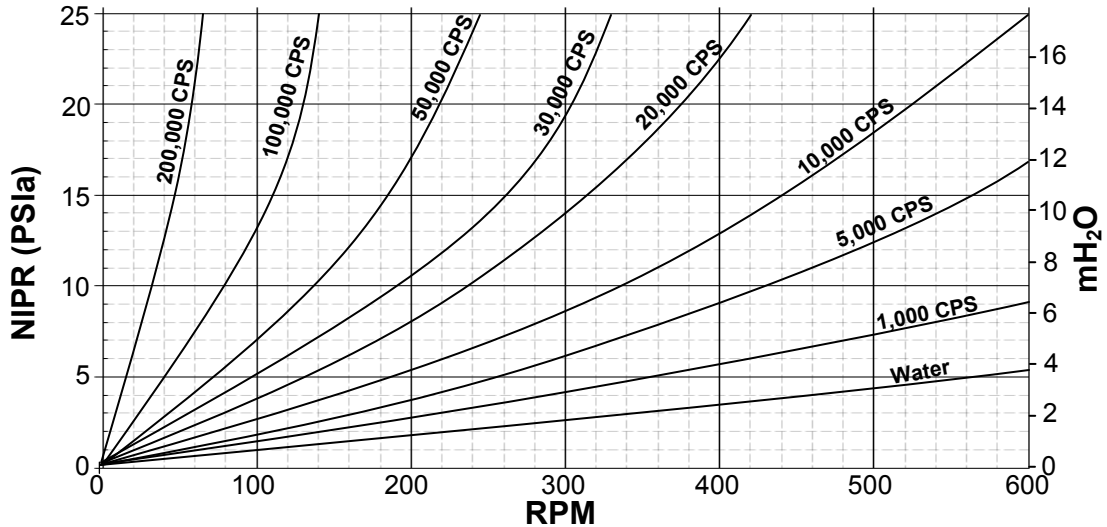
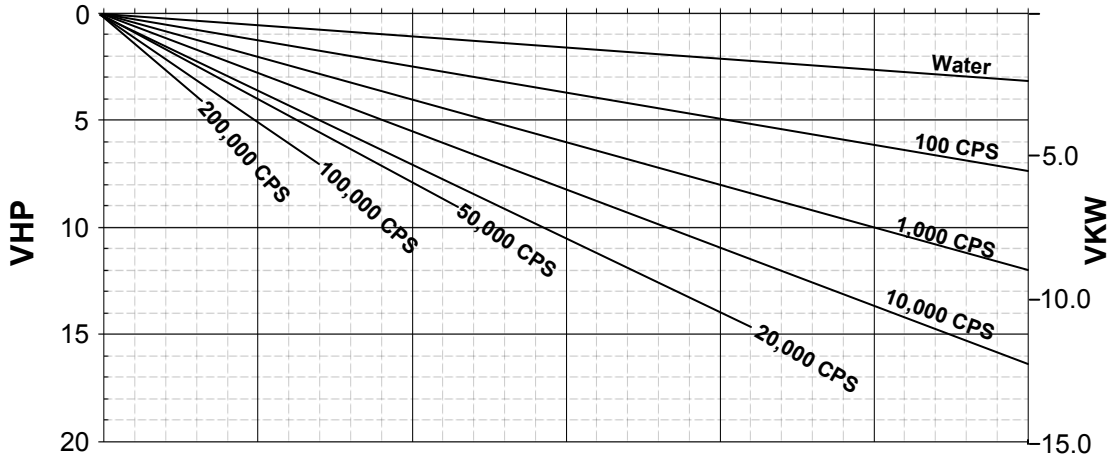
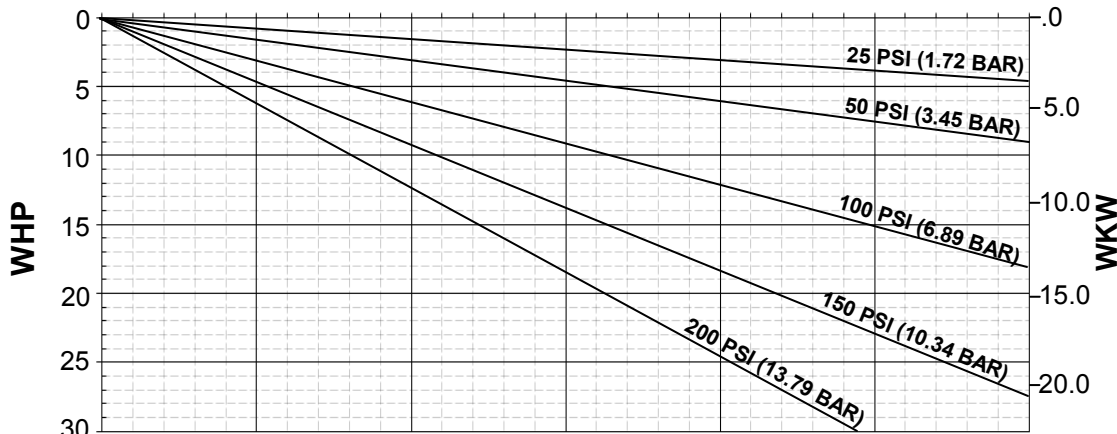
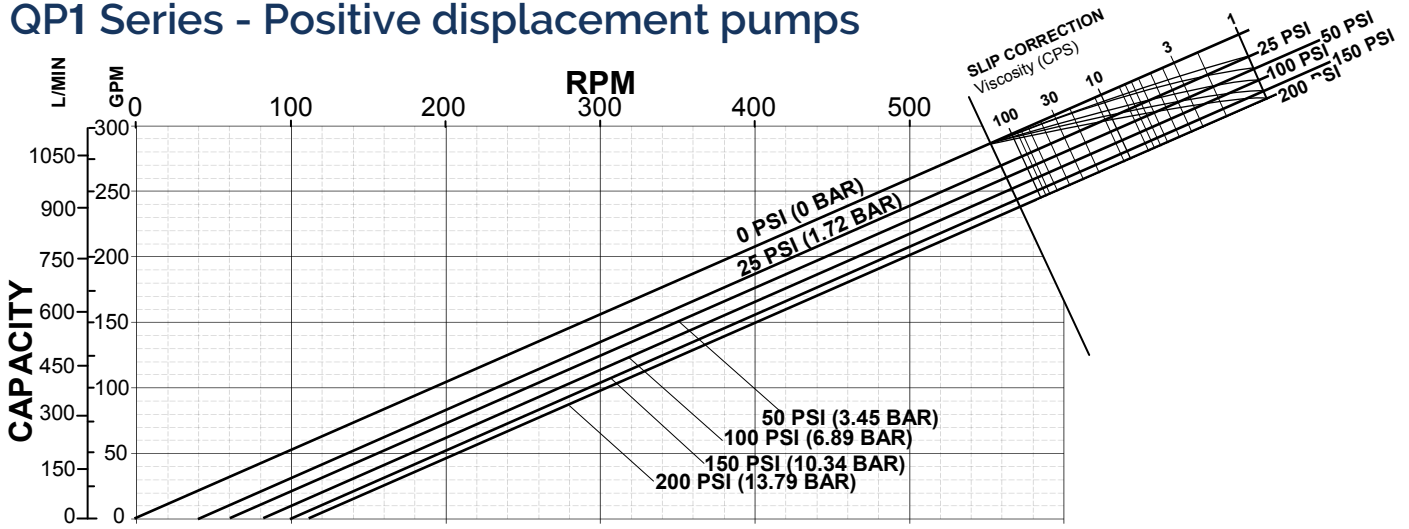

QP Series  
Model QP1-220

Standard Clearances  
Standard Port Size = 4.0"  
Displacement =  
0.522 Gal/Rev  
(1.976 L/Rev)

**BHP = WHP + VHP**

- Operating Specifications:
- 0-600 RPM Range
  - 200 PSI (13.8 bar) Max. Pressure
  - Temperature Range  
-40 °F (-40°C) to  
300 °F (149°C)

Subject to change without notice